

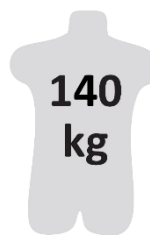

Helixon-S



①



②



③









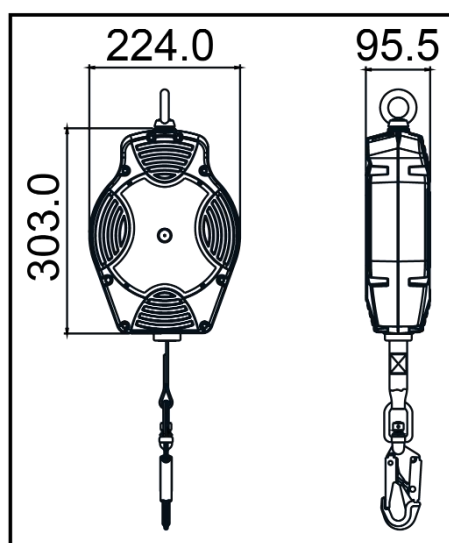

④









④



HS CODE
84798997
CARTON SIZE / PCS.
60 x 40 x 24 cm / 2
AET (EU) N°2777/10833-02/E01-02
Satra Technology Europe Ltd., N° 2777, Bracetown Business Park, Clonee, Dublin, D15YN2P, Ireland
MODULE D FI14/14003.01
SGS Fimko Oy, N°0598 Takomotie 8, 00380 HELSINKI, Finland
AET (UKCA) N°AB0321/16068-01/E02-01
Satra Technology Centre, N°0321 Wyndham Way, Telford Way, Kettering Northamptonshire, NN16 8SD, United Kingdom
MODULE D 11 IN14/14003
SGS United Kingdom Ltd., N°0120 Unit 202B, Worle Parkway, Weston-super-Mare, BS22 6WA, United Kingdom

REF.	FA 20 504 12
LG.  KG	12 m
CE	EN 360:2002
MAT.  	Polyamide 6 - 30% fiber glass PES 25 mm
	 FA 50 101 17 / FA 50 203 20 with fall indicator
	x2
R(kN)	15 kN
	YES PPE-R/11.060
	6.84 KG

LG.  KG	MAT.  	
Longueur Poids maxi utilisateur Length Max. user weight Longitud Peso máximo del usuario Lunghezza Peso Max. dell'utente Länge Höchstgewicht des Benutzers	Matière carter / sangle Material of casing / webbing Material cárter / correa Material dei carter / Cinghia Material Gehäuse / Gurt	Matière connecteur haut / connecteur bas Material of top connector / bottom connector Material conector alto / conector bajo Materiale connettore alto / connettore basso Material oberes / unteres Verbindungselement
		
Nombre d'émerillons Number of swivels Cantidad de eslabones giratorios Numero di tornichetti Anzahl der Wirbel		Homologué pour le travail à proximité d'arêtes vives Approved for work near sharp edges Homologado para trabajo cerca de aristas vivas Omologato per lavoro in prossimità di spigoli vivi Zugelassen für Arbeiten in der Nähe scharfer Kanten